

FOX

36

TUNING GUIDE



SAG SETTING

To achieve the best performance from your FOX suspension, adjust the air pressure to attain your proper sag setting. Sag is the amount your suspension compresses under your weight and riding gear. Sag range should be set to 15-20% of total fork travel.

For forks with the FIT4 and Grip dampers make sure to set sag with the compression lever in the OPEN mode, see page 5.

For forks with the HSC/LSC (RC2) or LSC (RC) damper: make sure to set sag with the LSC adjuster in the full counter-clockwise (OPEN) position, see page 6-7.

Watch the sag setup video at ridefox.com/sagsetup

Suggested Sag Measurements		
Travel	15% sag (Firm)	20% sag (Plush)
140 mm (5.5 in)	21 mm (0.8 in)	28 mm (1.1 in)
150 mm (5.9 in)	22 mm (.9 in)	30 mm (1.2 in)
160 mm (6.3 in)	24 mm (1.0 in)	32 mm (1.3 in)
170 mm (6.7 in)	26 mm (1.0 in)	34 mm (1.3 in)
180 mm (7.1 in)	27 mm (1.1 in)	36 mm (1.4 in)

Your fork has a 4 digit ID code on the back of the lower leg. Use this number on the Help page at www.ridefox.com to find out more information about your fork, including fork travel.

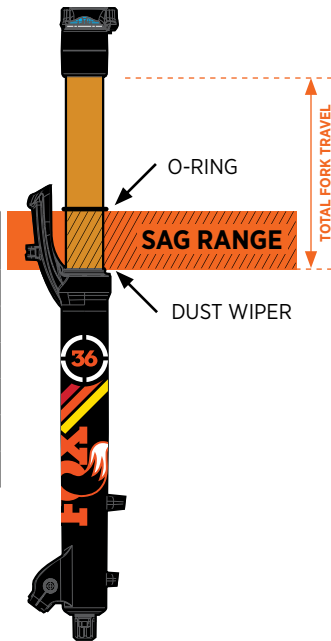

The recommended settings in this tuning guide are designed to be a **starting point**, in order to get you out on your first ride in as few steps as possible. Consult your bike manufacturer's instructions for setup recommendations.

As you ride and get used to your new fork, adjust your settings as needed. Detailed information and videos can be found in the online owner's manual.

Suggested Starting Points for Setting Sag		
Rider Weight (lbs)	Rider Weight (kgs)	FLOAT & Rhythm Pressure (psi)
120-130	54-59	55
130-140	59-64	59
140-150	64-68	63
150-160	68-73	67
160-170	73-77	75
170-180	77-82	76
180-190	82-86	80
190-200	86-91	85
200-210	91-95	89
210-220	95-100	93
220-230	100-104	97
230-240	104-109	102
240-250	109-113	106



Do not exceed maximum air pressure: **36 FLOAT** maximum air pressure is **120 psi**.

REBOUND ADJUSTMENT

The rebound adjustment is dependent on the air pressure setting. For example, higher air pressures require slower rebound settings. Use your air pressure to find your rebound setting.

Turn your rebound knob to the closed position, clockwise until it stops. Then turn it counter-clockwise to the number of clicks shown in the table below.

REBOUND

Rebound controls the rate of speed at which the fork extends after compressing.

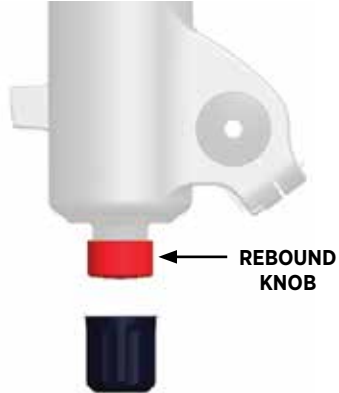

REBOUND KNOB

FLOAT Pressure (psi)	Recommended Rebound Setting FIT4	Recommended Rebound Setting GRIP/RC2
55	8	13
59	8	12
63	7	11
67	7	10
75	6	9
76	6	8
80	5	7
85	5	6
89	4	5
93	4	4
97	3	3
102	2	2
106	1	1

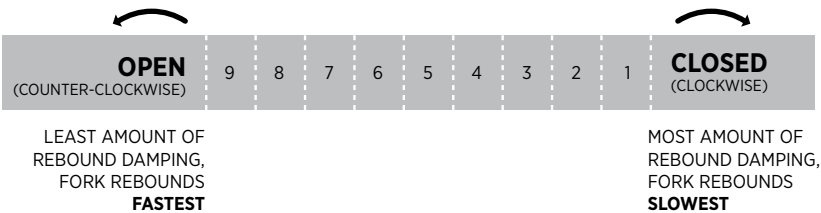

COMPRESSION ADJUSTMENTS

FIT4 3-POSITION LEVER

Begin with the 3-position lever in the OPEN mode.



The **3-position lever** is useful to make on-the-fly adjustments to control fork performance under significant changes in terrain, and is intended to be adjusted throughout the ride.

Use the OPEN mode during rough descending, the MEDIUM mode for undulating terrain, and the FIRM mode for smooth climbing.

*OPEN MODE ADJUST

Set the OPEN mode adjust to 18 clicks out (counter-clockwise until it stops).

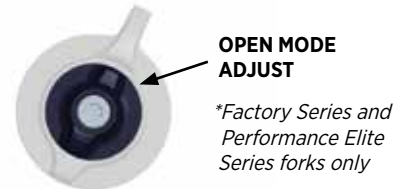

OPEN MODE ADJUST

**Factory Series and Performance Elite Series forks only*

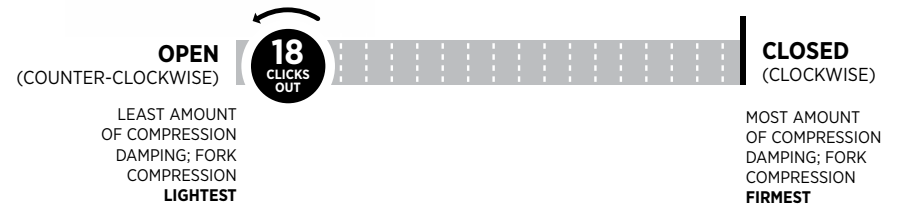

GRIP COMPRESSION ADJUST

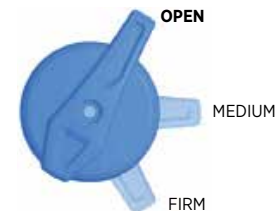

The **3-Position Micro Adjust** lever is useful to make on-the-fly adjustments to control fork performance. Use the positions between the OPEN, MEDIUM, and FIRM modes to fine-tune your compression damping.

The **2-Position Sweep Adjust (32 Rhythm forks only)** lever is useful to make on-the-fly adjustments to control fork performance. Use the positions between OPEN and FIRM modes to fine-tune your compression damping.

FACTORY SERIES HSC/LSC COMPRESSION ADJUSTERS

Use this diagram as a starting point for your compression adjusters.

Turn your compression adjusters to the closed position (full clockwise) until they stop. Then back them out (counter-clockwise) to the number of clicks shown below.



High-speed compression adjustment is useful to control fork performance during bigger hits, landings, and square-edged bumps.

Low-speed compression adjustment is useful to control fork performance during rider weight shifts, G-outs, and other slow inputs.

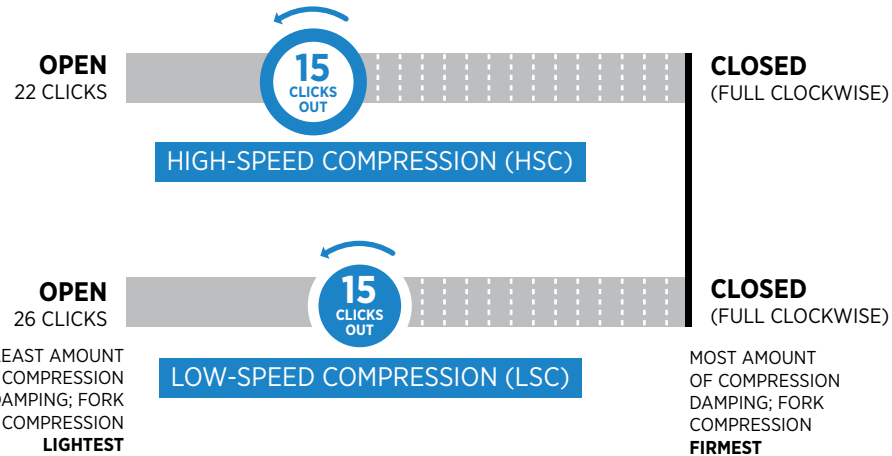

PERFORMANCE SERIES LSC COMPRESSION ADJUSTER

Use this diagram as a starting point for your compression adjuster.

Turn your compression adjuster to the closed position (full clockwise) until it stop. Then back it out (counter-clockwise) to the number of clicks shown below.



Low-speed compression adjustment is useful to control fork performance during rider weight shifts, G-outs, and other slow inputs.

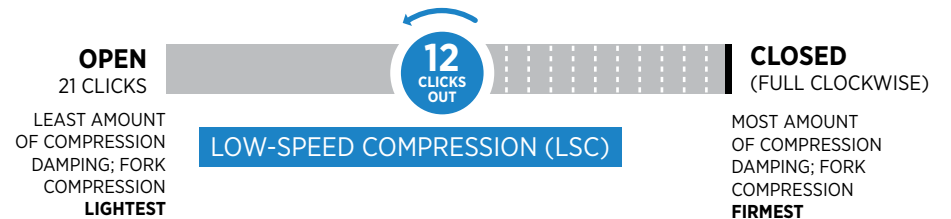

CONVERTING TO THE 20MM AXLE

1. Remove the pinch bolts, axle pinch bars, and 15mm axle slit shims.
2. Squeeze the 15mm axle adapters with smooth jawed pliers, compressing their slits while pulling toward the opposite dropout to remove.
3. Install the 20mm axle slit shims into the dropout slits.
4. Reinstall the pinch bolts and axle pinch bars.

⚠ WARNING: The 20mm axle slit shims must be used when using the 20mm axle. Leaving the 20mm axle slit shims out when using the 20mm axle can allow for dropout damage to occur, which can lead to a loss of control of the bicycle that can result in SEVERE INJURY OR DEATH.

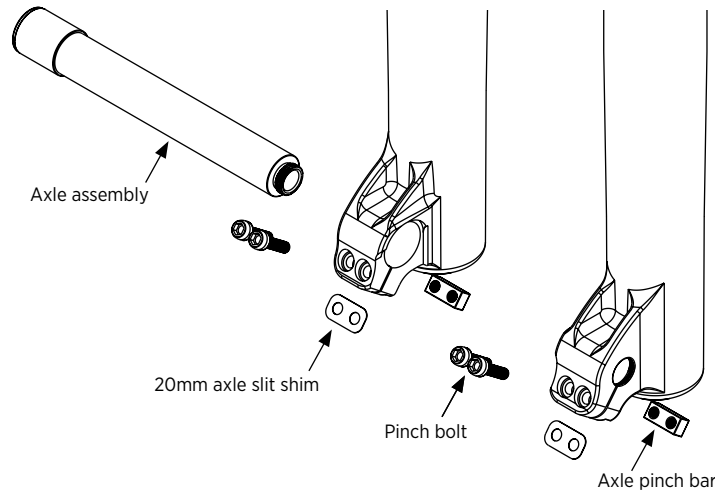

CONVERTING TO THE 15MM AXLE

1. Remove the pinch bolts, axle pinch bars, and 20mm axle slit shims.
2. Coat the axle adapters with a thin film of multi-purpose lithium based grease or suspension oil.
3. Press the adapters into their appropriate dropouts making sure to align the slit in the adapter with the slit in the dropout.
4. If necessary, you can rotate the axle adapter by squeezing it with smooth jawed pliers to compress the slit and allow it to rotate until aligned.
5. Install the 15mm axle slit shims into their correct dropouts as shown.
6. Reinstall the pinch bolts and axle pinch bars.

⚠ WARNING: The 15mm axle should only be used with the 15mm axle adapters and 15mm axle slit shims. Do not use the 15mm axle without the 15mm axle adapters. Do not use the 15mm axle with the 20mm axle slit shims. Failure to use the proper adapters and axle slit shims with the 15mm axle can damage the fork dropouts which can lead to a loss of control of the bicycle which can result in SEVERE INJURY OR DEATH.

⚠ WARNING: Never attempt to modify axle slit shims or axle adapters. Modification of these parts can lead to improper installation which can lead to a loss of control of the bicycle which can result in SEVERE INJURY OR DEATH.

⚠ WARNING: When using the 15mm axle slit shims, make sure to install the notched shim in the rider's left dropout. Failure to install the 15mm axle slit shims in their correct locations may result in damage to the dropout that can lead to a loss of control of the bicycle which can result in SEVERE INJURY OR DEATH.

⚠ WARNING: Never attempt to force any parts to fit. Doing so may result in dropout damage, which can lead to a loss of control of the bicycle that can result in SERIOUS INJURY OR DEATH.

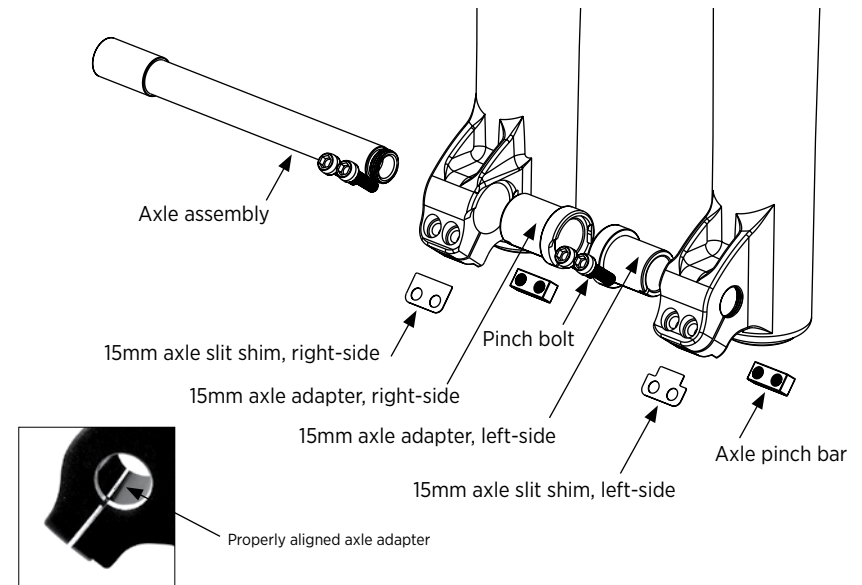

INSTALLING THE FRONT WHEEL - QR

Wheel installation is identical for both the 15x100 mm and 15x110 mm axles.

1. Install the front wheel into the fork dropouts. Slide the axle through the non-drive side dropout and hub.
2. Open the axle lever.

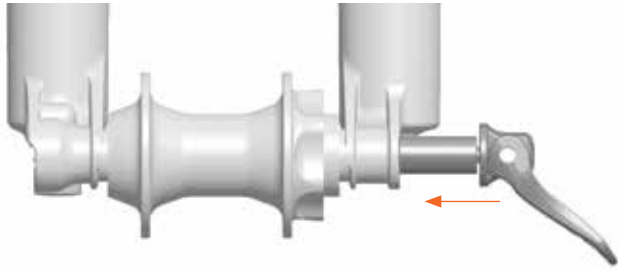

3. Turn the axle clockwise 5-6 complete turns into the axle nut.
4. Close the lever. The lever **must** have enough tension to leave an imprint on your hand.
5. The closed lever position **must** be between 1-20 mm in front of the fork leg.
6. If the lever does not have enough tension, or has too much tension when closed at the recommended position (1-20 mm in front of the fork). See the next page for adjustment instructions.

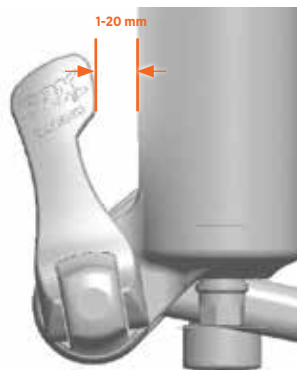

KABOLT INSTALLATION

Wheel installation is identical for both the 15x100 mm and 15x110 mm Kabolt axles.

1. Install the front wheel into the fork dropouts. Slide the Kabolt axle through the non-drive side dropout and hub.
2. Use a 6 mm hex wrench to torque the Kabolt axle (clockwise) to 17 Nm (150 in-lb).



⚠ WARNING: Use hand pressure only. Never use any tool to tighten the 15QR levers onto the lower legs. Over-tightening the levers can damage the axle or fork dropouts, leading to a sudden failure with one or more of these components, resulting in **SERIOUS INJURY OR DEATH.**

⚠ WARNING: Failure to secure the axle properly can cause the wheel to become detached from the bicycle, resulting in **SERIOUS INJURY OR DEATH.**

INSTALLING THE FRONT WHEEL - QR

Wheel installation is identical for both the 15x100 mm and 15x110 mm axles.

1. Install the front wheel into the fork dropouts. Slide the axle through the non-drive side dropout and hub.
2. Open the axle lever.

3. Turn the axle clockwise 5-6 complete turns into the axle nut.

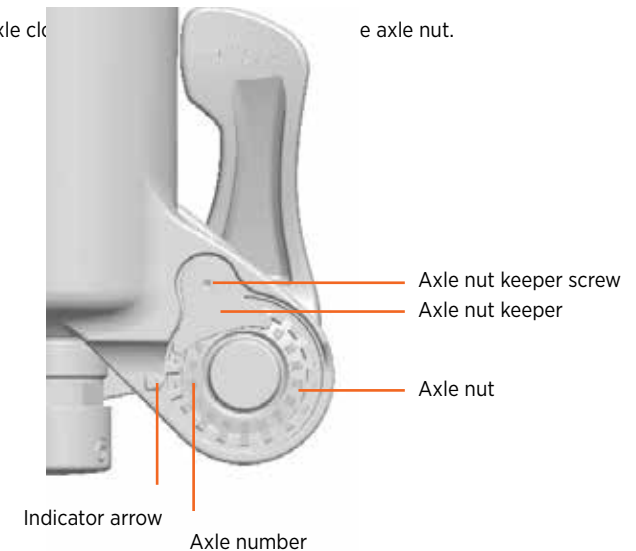

INSTALLING THE FRONT WHEEL - THRU-AXLE

Wheel installation is identical for both the 15 mm and 20 mm axles.

1. Install the front wheel into the dropouts and slide the axle through the dropouts and hub.
2. Using a 5 mm hex wrench, torque the axle to 19 in-lb (2.15 Nm).
3. Torque the two pinch bolts on the rider's left dropout to 19 in-lb (2.15 Nm).
4. Compress the fork a couple of times to let the right side of the dropout float and settle to its low-friction point.
5. Torque the two pinch bolts on the rider's right dropout to 19 in-lb (2.15 Nm).

MOUNTING DISC BRAKES

The 36 FLOAT uses 180 mm post mounts that allow you to bolt your caliper directly to the fork and utilize a 180 mm rotor.

If your current 180 mm brake setup came with bolts and a caliper spacer, you may need to source shorter bolts as you will not need a caliper spacer when using a 180 mm rotor.

If using a 203 mm rotor, you will need to source the appropriate caliper spacer and bolts. Contact the brake manufacturer for further information.

⚠ WARNING: Follow your brake manufacturer's installation instructions for proper installation and adjustment of the brake system. Failure to properly install and adjust your brakes can lead to a loss of control of the bicycle which can result in SEVERE INJURY OR DEATH.

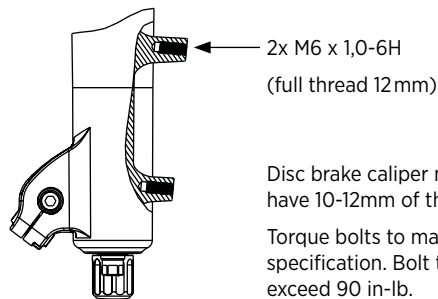

Disc brake caliper mount bolts must have 10-12mm of thread engagement.
Torque bolts to manufacturer's specification. Bolt torque must not exceed 90 in-lb.

ADDITIONAL TUNING OPTIONS

CLIP-ON VOLUME SPACERS

Changing volume spacers in the 36 FLOAT fork is an easy internal adjustment that allows you to change the amount of mid stroke and bottom out resistance.

If you have set your sag correctly and are using full travel (bottoming out) too easily, then you could install one or more spacers to increase bottom out resistance.

If you have set your sag correctly and are not using full travel, then you could remove the spacer to decrease bottom out resistance.

Installation procedure and tuning options are available online at: ridefox.com/ownersmanuals

36 FLOAT Volume Spacer Configurations		
Travel	Volume Spacers Factory Installed	*Max Volume Spacers
180 mm	0	4
170 mm	0	5
160 mm	1	6
150 mm	2	7
140 mm	4	8
100 mm (831)	9	10

TYPICAL AIR SPRING CURVES

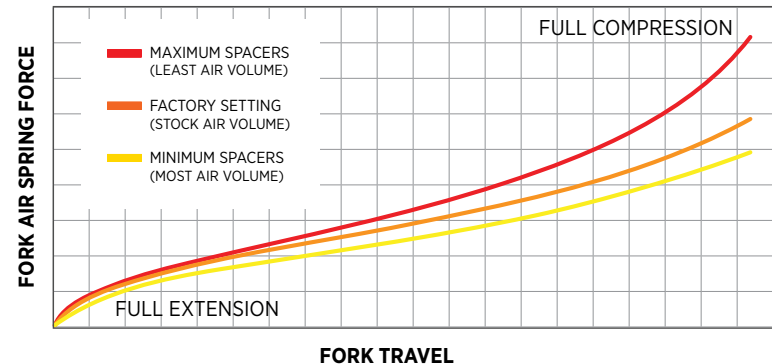

SEE ADDITIONAL INFORMATION AND VIDEOS:

36 FLOAT ridefox.com/36setup

NOTES



©FOX FACTORY, INC. 2016 // 1.800.FOX.SHOX
915 Disc Drive · Scotts Valley, CA 95066 USA
TEL 831.768.1100

605-00-162 REV A



Redefine Your Limits