

FOX REDEFINE **YOUR LIMITS**

FLOAT 3 EVOL, R, RC, RC2 **FACTORY SERIES** OWNERS MANUAL



CONTENTS

CONGRATULATIONS.....	3
CONSUMER SAFETY	3
UNDERSTANDING THE FLOAT 3 EVOL SERIES	4
FOX PUMP	5
OPTIONS	5
ADJUSTING PROGRESSIVE AIR SPRING	6
REFERENCE AIR PRESSURES	7
TEMPERATURE DEPENDENCY.....	7
INSTALLING YOUR SHOCKS.....	8
MEASURE STOCK SETTINGS	9
FLOAT 3 EVOL SERIES INSTALLATION	11
FLOAT 3 EVOL SERIES SETUP	12
TUNING THE FLOAT 3 EVOL SERIES.....	14
REBOUND ADJUST	14
DUAL-SPEED COMPRESSION (DSC) ADJUST	15
LOW-SPEED COMPRESSION (LSC) ADJUST	15
HIGH-SPEED COMPRESSION (HSC) ADJUST	15
TUNING NOTES.....	16
MAINTENANCE	17
SERVICE	17
WARRANTY	17

NOTICE: THE SNOWMOBILE PICTURED IN THIS MANUAL MAY NOT RESEMBLE YOUR ACTUAL SNOWMOBILE. THE PROCEDURES OUTLINED IN THIS MANUAL WILL INSTRUCT YOU TO MOUNT, SET-UP AND ADJUST THE FOX FLOAT 3 EVOL SERIES SHOCK ABSORBER ON YOUR PARTICULAR SNOWMOBILE MODEL.

CONGRATULATIONS

Thank you for choosing FOX FLOAT 3 EVOL SERIES shock absorbers for your snowmobile. In doing so, we believe that you have chosen the finest suspension products in the world.

FOX shocks have been designed, tested and manufactured in the USA for more than 35 years.

As a consumer and supporter of FOX products, you need to be aware of the importance of setting up your shocks correctly to ensure maximum performance. This manual provides step-by-step instructions on how to set-up and maintain your shocks. It is a good idea to keep your proof of purchase with this manual and refer to it for service and warranty issues.

This manual does not contain step-by-step shock rebuild instructions. Rebuilding should be carried out by an authorized FOX service technician.

CONSUMER SAFETY

WARNING: Riding a Snowmobile can be dangerous and can result in DEATH OR SERIOUS INJURY.

Take responsibility for yourself and others seriously, and read the following safety tips:

- Keep your vehicle and its suspension systems in optimal working condition.
- Always wear protective clothing, eye protection and a helmet
- Know your limits and ride within them!

The FOX FLOAT 3 EVOL SERIES shock contains a high-pressure nitrogen charge. The shock should only be opened by a FOX technician.

WARNING: Opening a nitrogen pressurized shock can be dangerous and can result in SERIOUS INJURY OR DEATH. NEVER attempt to disassemble the damper of your FLOAT 3 EVOL SERIES shock. Do not puncture or incinerate the shock absorber damper portion. Always wear eye protection when installing or adjusting your shock absorber.

UNDERSTANDING THE FLOAT 3 EVOL SERIES

FOX FLOAT (FOX Load Optimizing Air Technology) 3 EVOL SERIES air shocks are high-performance shock absorbers that use air as springs, instead of heavy steel coil springs or expensive titanium coil springs. Underneath that air sleeve is a high-performance, velocity-sensitive, shimmed damping system. FLOAT 3 EVOL SERIES air shock dampers contain high pressure nitrogen gas and FOX high viscosity index shock oil separated by an Internal Floating Piston system. This helps to ensure consistent, fade-free damping in most riding conditions.

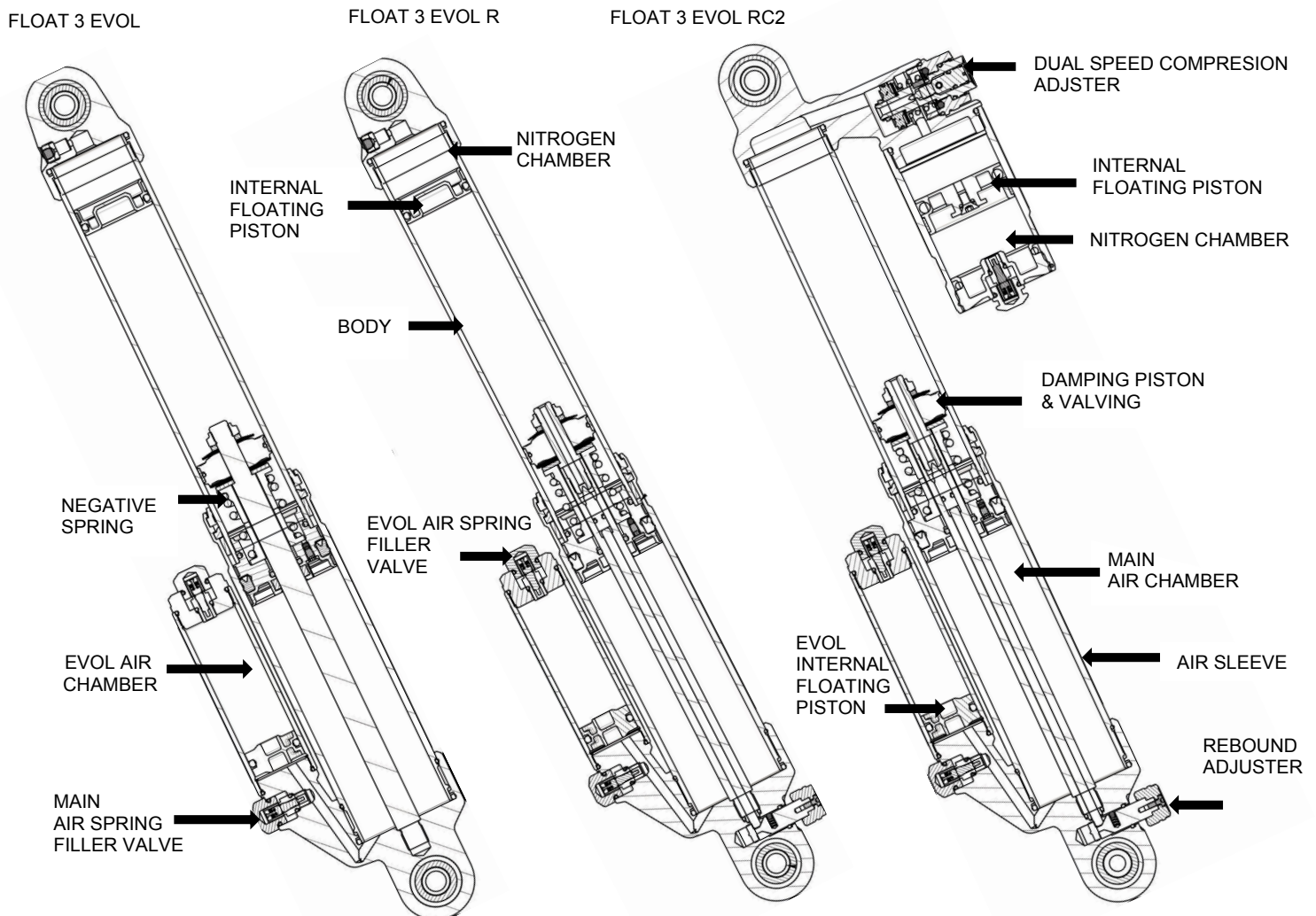

FLOAT 3 EVOL SERIES shocks are built using 6061-T6 aluminum for lightweight and strength. The chromed damper shaft is super-finished for low friction and long seal life. All of the seals and wipers are engineered specifically for FLOAT 3 EVOL SERIES. The damper shaft and seals are contained within the air sleeve, protecting them from dirt, water and ice.

FOX PUMP

Your FLOAT 3 EVOL SERIES shock absorbers are shipped with a FOX dual scale air pump, shown below.



0-300psi Dual Scale Pump P/N 027-00-008

AVAILABLE OPTIONS



0-300psi Digital Pump P/N 027-00-010



Body Guard Kit, black shown, optional colors available

ADJUSTABLE PROGRESSIVE DUAL-STAGE AIR SPRING

Air springs are not just lightweight they are also progressive. What does that mean? As the graph below shows, during the second half of shock travel, the spring force builds rapidly. This virtually eliminates any harsh bottoming of the suspension and provides a “bottomless” feel.

With just one pump you can make quick, easy changes to your setup to fine tune your shock’s spring curve. Using air, there is an infinite number of spring rates available.

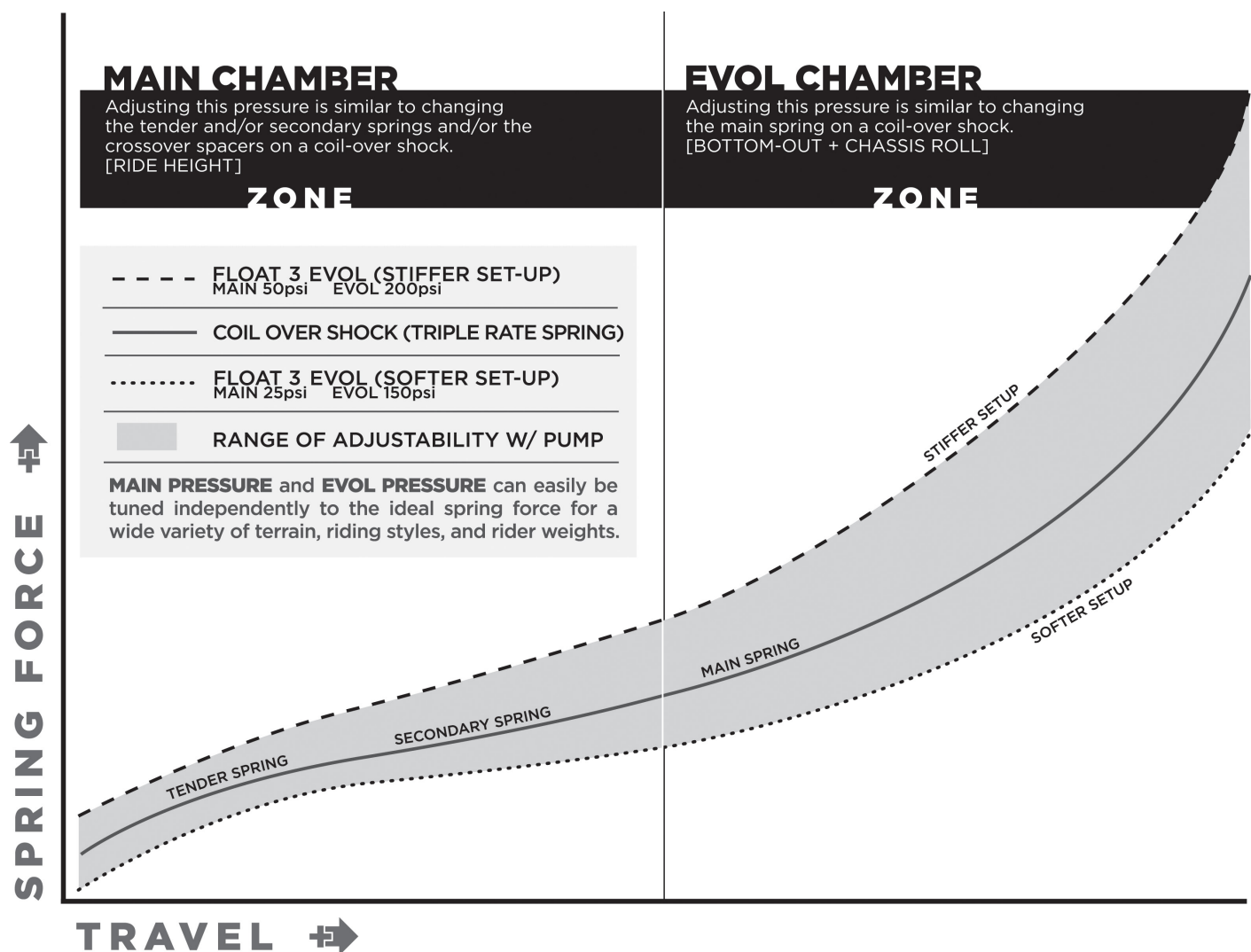

As you can see, by changing the pressures in the **MAIN** air chamber and the **EVOL** air chamber, you can get much softer or much firmer than a coil-over shock without ever having to change out a spring.

Your FLOAT 3 EVOL SERIES shocks come in the box ready-to-ride, but we encourage you to follow the procedures outlined in this manual to optimize their performance.

The air pressure in the EVOL air chamber is adjusted to control the vehicle corner roll and bottom-out characteristics in the last 1/3 of shock travel; the pressure in the MAIN air chamber is adjusted to change ride height and the suspension stiffness of the snowmobile.

Reference Air Pressures

	EVOL Air Chamber	Main Air Chamber
Mountain/Backcountry	120-150	35-65
Performance/Trail	160-180	35-95
Sno-Cross/X-Country	200-250	100-120

The effects of changing the EVOL air chamber pressure and MAIN air chamber pressure are shown in the graphs below:

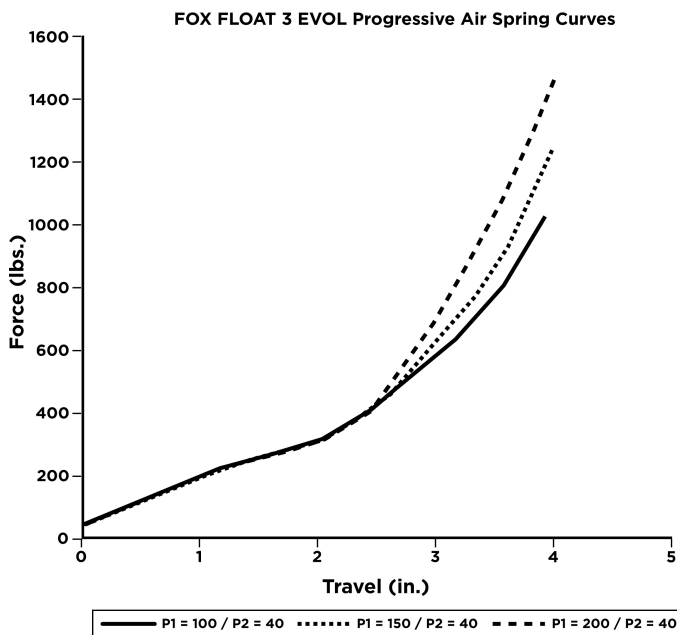

Changing EVOL Air Chamber pressure adjusts the bottom-out resistance of the shock.

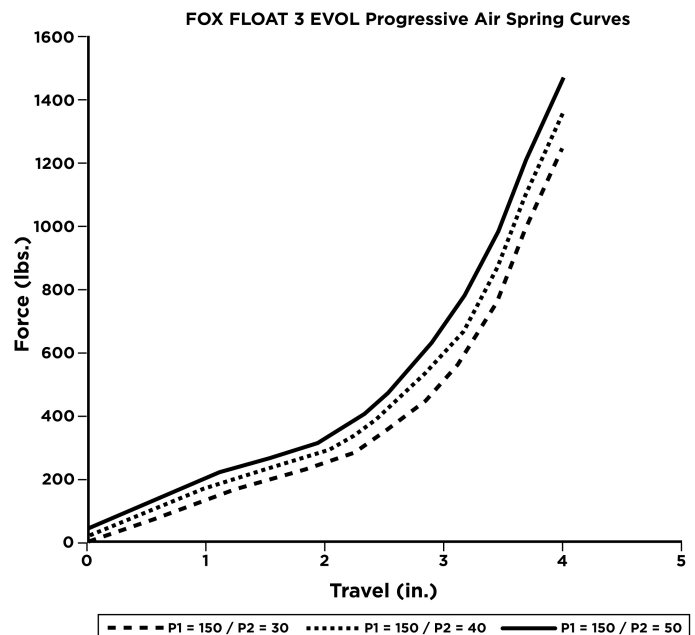

Changing MAIN Air Chamber pressure steadily adjusts the spring curve.

TEMPERATURE DEPENDENCY

The air pressures in the FLOAT 3 EVOL series air shocks are slightly temperature dependent with roughly a 10psi air pressure change over a 100-degree temperature change. Because of this, it is best to set the pressures in temperature conditions close to the ambient temperature anticipated during riding. When temperatures change by more than 30 degrees Fahrenheit—or 17 degrees Celsius—it is recommended that the pressure settings be reset.

For example, if the temperature outside is 40°F (4°C) and the pressures are set while the snowmobile is in a garage in which the ambient temperature is 70°F (21°C), the shocks will be under-pressurized when taken outside due to the cold air temperature. Therefore, it is imperative that the pressures are re-adjusted when the snowmobile/shocks are taken from extreme warm to cold temperatures and vice-versa. Once the pressures are set for a given temperature, they will remain stable throughout the ride.

INSTALLING YOUR SHOCKS

If you do not have the proper equipment, tools, floor jack or jack stand, torque wrench, ratchet socket set with wrench set and abilities to correctly install your shock, have the shock absorbers installed by a professional technician. Your shock absorbers come supplied with the correct reducers pre-installed to mount them correctly to your vehicle.



WARNING: CONTACT FOX IF THESE REDUCERS DO NOT FIT CORRECTLY. CORRECT SHOCK MOUNTING IS CRITICAL FOR CORRECT OPERATION AND FOR YOUR SAFETY.



DO NOT REMOVE NITROGEN FILL VALVE

WARNING: DO NOT REMOVE RESERVOIR NITROGEN FILLER CAP OR ATTEMPT TO CHANGE NITROGEN PRESSURE. DAMAGE TO SHOCK ABSORBER CAN OCCUR.

Shock absorbers equipped with rebound adjust and compression adjust low speed and high speed are preset. But it is recommended that you check the settings by counting the number of full clicks in clockwise until adjuster stops. Back the adjuster out the same number of full clicks you turned the adjuster in. Note these settings in TUNING NOTES Section.

MEASURE STOCK SETTINGS

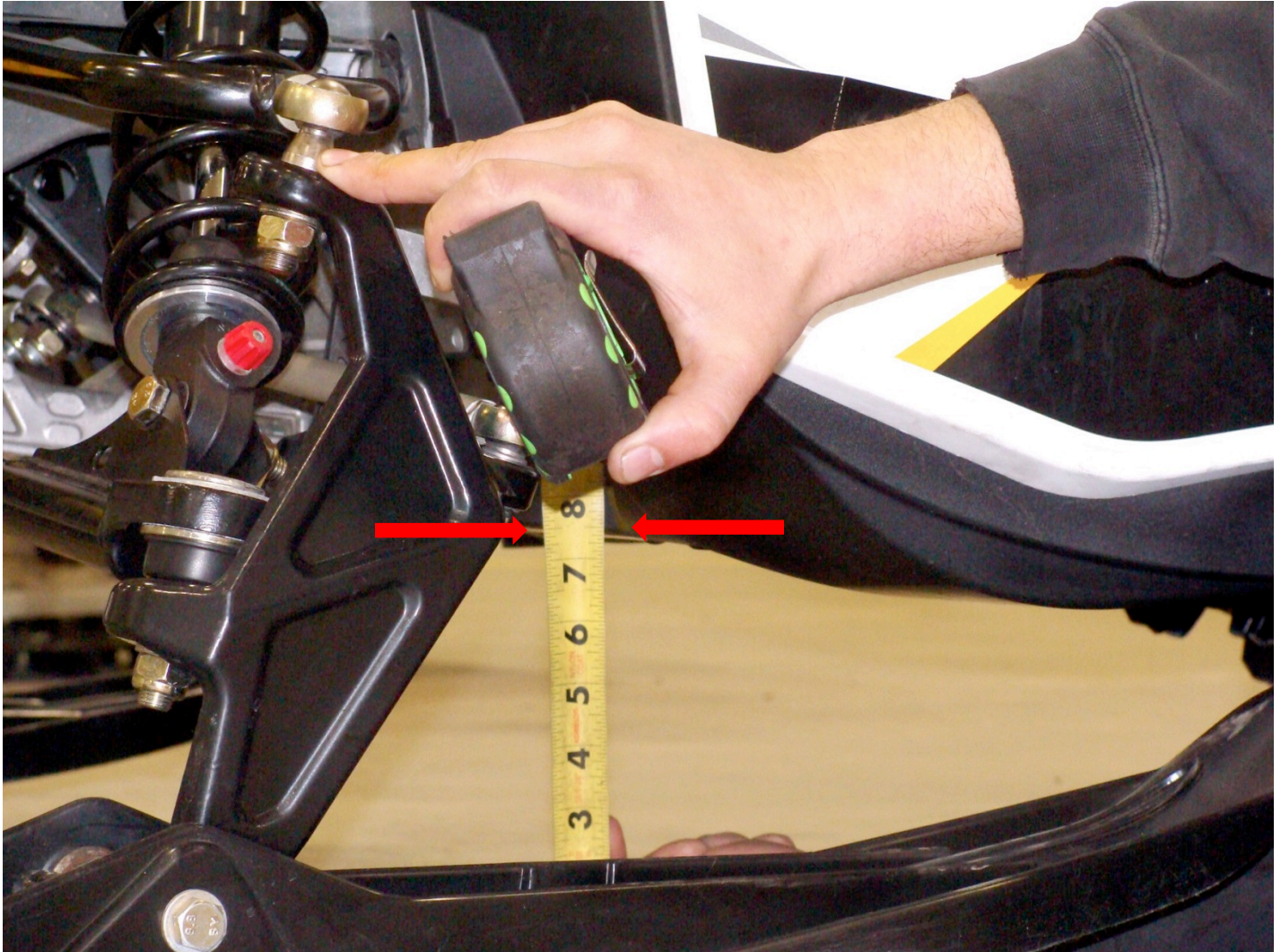

Step 1 BEFORE REMOVING STOCK SHOCK ABSORBERS

Start with the vehicle on a flat surface. Push down on the front bumper 3 times to set the front end. Measure the ground clearance of stock vehicle with the rider on board from the low point of the chassis. This will be measurement A = 7.375"
This measurement is known as ride height.

Ride height is measured with the intended rider and gear on board the vehicle when taking the measurement.

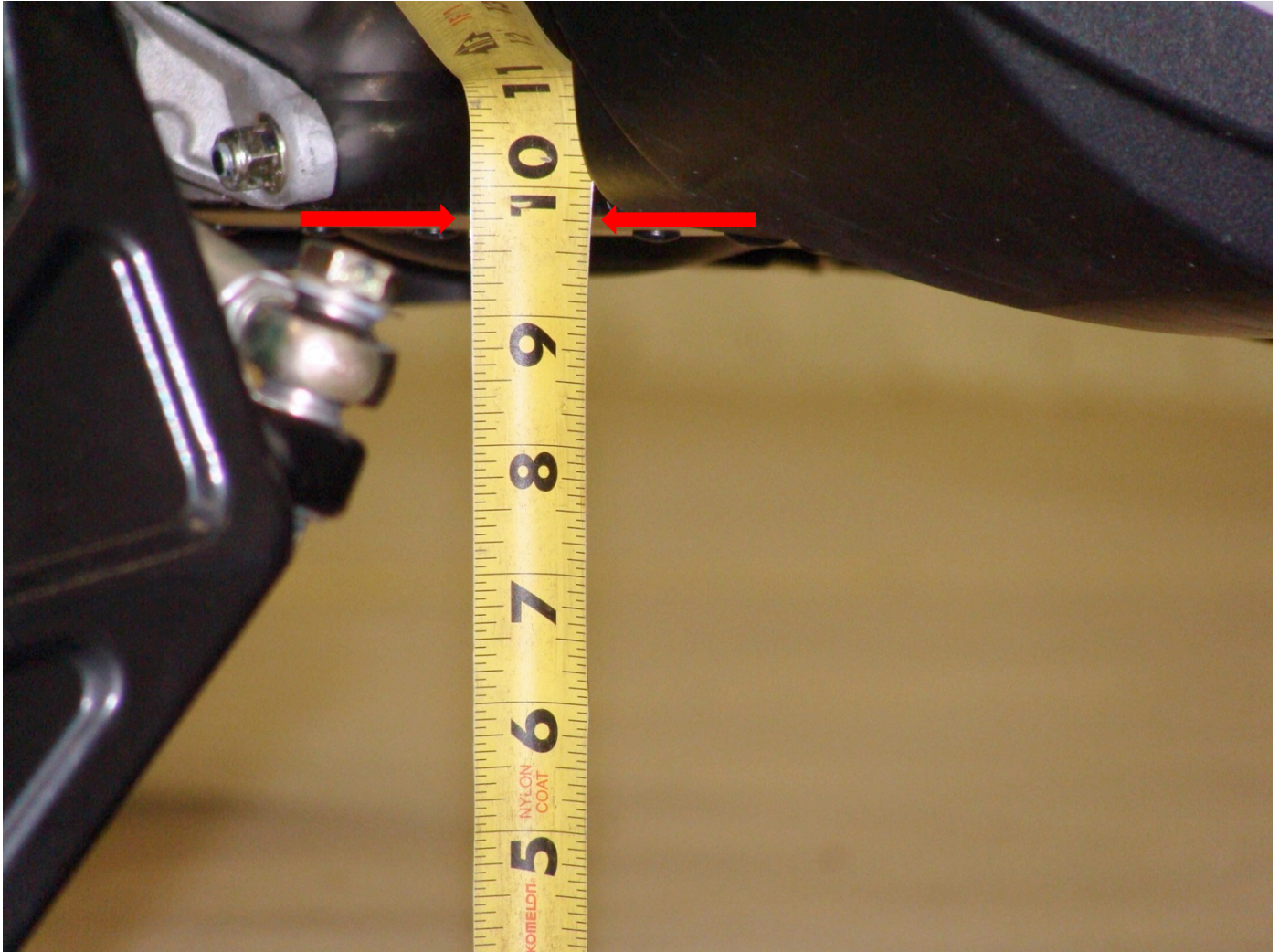

Step 2 Raise the front end up until the shocks fully extend or the ski is just about to come off the floor. Re-measure from the previous point on the chassis to the ground. This will be measurement B (Example 9.750") Full Extension

Step 3 **B - A = Sag Example 9.750" - 7.375" = 2.375" of Sag**
Use this measurement to set up your FOX FLOAT 3

Full Extension – Ride Height = Sag

Sag requirement is dependent on your vehicle, rider weight and usage. Sag requirements may vary. Heavier vehicles and riders may require more sag for optimal performance.

FLOAT 3 EVOL SERIES INSTALLATION



FLOAT 3 EVOL



FLOAT 3 EVOL R



FLOAT 3 EVOL RC2

Step 1 Ensure that your snowmobile is safely supported with a floor jack or jack stand and the skis off the ground. The suspension should be fully extended before removing the stock shocks. Install your FOX FLOAT 3 EVOL series shock absorbers with the air sleeve orientated as pictured above.

Step 2 Torque the original hardware to manufacturer's specifications. FOX FLOAT 3 shocks air chambers do come pre-pressurized, but it is recommended that you check air pressure on initial setup before riding.

FLOAT 3 EVOL SERIES SETUP



Step 1 Ensure that your snowmobile is safely supported with a floor jack or jack stand and the skis off the ground. Remove the EVOL air spring filler cap.

NOTE: ALWAYS SET EVOL CHAMBER AIR PRESSURE BEFORE SETTING MAIN CHAMBER AIR PRESSURE.

Step 2 Thread the pump onto the EVOL air filler valve until it is fully seated and air pressure registers on the pumps high pressure scale.

NOTE: WHEN YOU ATTACH THE PUMP, THE HOSE AND GAUGE WILL FILL WITH AIR FROM THE AIR CHAMBER RESULTING IN A LOWER AIR PRESSURE READING THAN THE SHOCK WAS ORIGINALLY SET AT. THIS IS NORMAL.

Step 3 Pump the shock up to the desired air pressure setting. You can decrease air pressure by pushing the BLACK-BLEED valve on pump. (WARNING: DO NOT EXCEED 300PSI IN the EVOL CHAMBER)

Pushing the bleed valve halfway down and holding it there will allow air to escape continuously from the pump and shock. Pushing the bleed valve all the way down and releasing it will allow only a small amount of pressure to escape (micro-adjust). When unthreading the pump from the Schrader valve, the sound of air loss is from the pump hose only and not the shock. Your shock pressure will not change.



Step 4 Thread the pump onto the MAIN air filler valve until it is fully seated and air pressure registers on the pumps low pressure scale.

Step 5 Pump the shock up to the desired air pressure setting. You can decrease air pressure by pushing the BLACK-BLEED valve on pump. (WARNING: DO NOT EXCEED 150PSI IN THE MAIN CHAMBER)

Step 6 Lower the vehicle to the floor and remove the jack. Push down on the front bumper 3 times to set the front end. Measure ground clearance of the vehicle with the rider on board from previous measuring point of the chassis. This will be measurement C (Example 7.0 inches) Ride Height

Step 7 **B - C = new Sag Example 9.750" - 7.0" = 2.750" of sag**

Step 8 In our example you would have to increase the air chamber pressure to increase ride-height and reduce sag by repeating previous steps one through four. However if the ride height would have been too high and sag too low, you would have to decrease air chamber pressure.

Full Extension – Ride Height = Sag

Step 9 f Reinstall the air spring filler valve caps.

TUNING THE FLOAT 3 EVOL SERIES

SPRING FORCE

At this point you have set the sag of your vehicle by adjusting the air chamber pressure. Your spring force should be near its optimal setting. If you feel that the front of the vehicle is too low as you are riding, increase the air chamber pressure by 5psi. If the vehicle is too high, decrease the air chamber pressure by 5psi.

If you feel that you are passing through your available travel too quickly on big bumps or have too much roll in corners, try increasing the EVOL air chamber pressure by 10 PSI. If you feel that you are not fully utilizing your available travel or the sled does not roll over easy in corners (deep snow powder turns), try decreasing the EVOL air chamber pressure by 10 PSI.

Step 1 Lift the vehicle's front end off the ground.

Step 2 Release the air pressure from the MAIN air chamber.

Step 3 Re-set the EVOL air chamber pressure. (Do not exceed 300 psi)

Step 4 Re-set the MAIN air chamber pressure. (Do not exceed 150 psi)

Step 5 Reinstall air spring filler caps.

REBOUND ADJUST



Rebound Adjuster

The Rebound Adjust feature on your FLOAT 3 EVOL RC2 shocks gives the ability to externally adjust the shock rebound damping. Adjustments are made by turning RED knob or use a small flat-bladed screwdriver to turn the adjuster on the Air Sleeve Body Cap located on the end of the shock absorber.

For slower rebound, turn the knob/screw clockwise.

The rebound adjuster has about 20 clicks of adjustment. The factory setting is 12 clicks out. The performance of the shock at this setting is close to the performance of the non-adjustable shock and is a good all-around setting.

The rebound damping affects how quickly the shock extends (rebounds). This adjustment affects how quickly the ski rebound when travelling through a series of large bumps and how quickly the front end responds in the corner.

The optimum rebound setting is usually found with the minimum damping required to give acceptable control. Excessive rebound damping will typically be felt as the suspension "packing." This can often be seen or felt as the vehicle travels through a series of similar-sized, successive bumps. It works well for the first two or three bumps and then bottoms hard on the third or fourth. This is because the shock has not rebounded quickly enough, and the shock "packs" into compression.

DUAL-SPEED COMPRESSION (DSC) ADJUST

The FOX DSC valve is standard on FLOAT 3 EVOL RC2 shocks and gives the ability to externally adjust the damping. The DSC has about 24 clicks of low-speed adjustment and about 22 clicks of high-speed adjustment. The factory setting is 12 / 12. The performance of the shock at this setting is close to the performance of the non-adjustable shock and is a good all-around setting. The DSC valve gives the driver the ability to tune the shock for different terrain / personal preference on either side of this setting (softer or stiffer).

LOW-SPEED COMPRESSION (LSC) ADJUST



LSC Adjuster

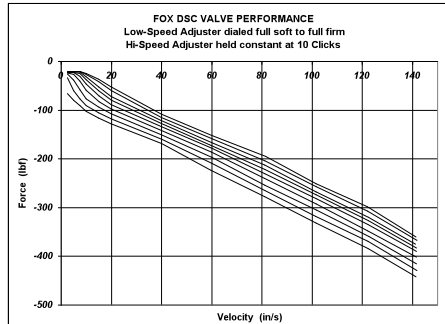

LSC (LOW-SPEED COMPRESSION) ADJUSTMENT

The LSC is adjusted using a flat-blade screwdriver in the middle of the adjuster.

More damping = stiffer = clockwise

LSC primarily affects the compression damping during slow suspension movements such as G-outs or smooth jump landings. It also affects ride comfort of the vehicle.

Choose a LSC setting that gives good body control anti-roll in corners, without causing excessive harshness or loss of front end traction. The graph above shows the typical range of adjustability for the LSC adjuster from full-firm to full-soft with the HSC adjuster held constant at 10 clicks out.

HIGH-SPEED COMPRESSION (HSC) ADJUST



HSC Adjuster

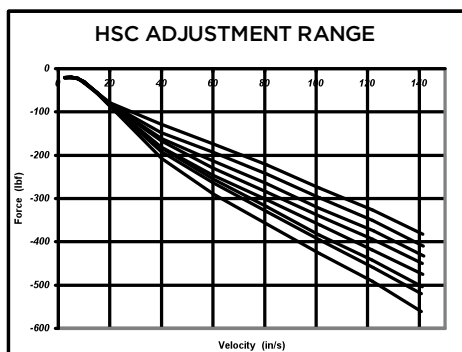

HSC (HIGH-SPEED COMPRESSION) ADJUSTMENT

The HSC is adjusted using a 17 mm socket

More damping = stiffer = clockwise

The HSC adjuster affects the compression damping during medium-to-fast suspension movements such as steep jump faces, harsh flat landings and aggressive whoops. The goal is to run as little high-speed compression damping as possible without bottoming. The graph above shows the typical range of adjustability for the HSC adjuster from full-firm to full-soft with the LSC adjuster held constant at 10 clicks.

TUNING NOTES

DATE	COMMENTS	FULL EXTENSION	RIDE HEIGHT	= SAG	EVOL AIR PSI	MAIN AIR PSI	LSC ADJ	HSC ADJ	REB ADJ

MAINTENANCE

PROPER INSPECTION AND MAINTENANCE IS ESSENTIAL TO MAINTAIN THE PERFORMANCE AND RELIABILITY OF YOUR SHOCK ABSORBERS.

You should keep the shock clean and free of dirt, ice and snow.

It is important to keep the shock absorbers clean and free of residue. The Samurai Sealing System in the air sleeve will clean deposits from the shock body and reduce the amount of debris entering the air sleeve. This will add to main air sleeve seal life. When cleaning the vehicle avoid using a high-pressure washer near the seals as this could drive debris inside the shock air sleeve.

Ideally the shocks should be clean around the adjusters when changing the damping setting (if fitted). A small blast of contact cleaner or brake cleaner before making adjustments will keep these parts clean and operating smoothly for years.

The service interval depends on how frequently and severely the snowmobile is ridden. As a guideline, if you race every weekend, you may want to change the oil in your shock at least once during the season. Otherwise, it is generally recommended to service the air sleeves at a minimum of once per year, with complete shock service every 3000 to 5000 miles. FOX or an authorized factory service center can perform these procedures.

SERVICE

Contact FOX Service Center at 1.813.740.4619 or psservicemw@ridefox.com to receive a return authorization number before shipping shocks to one of the following service centers:

WARRANTY

All FOX products have a one-year warranty on defects in materials or workmanship. Please view the full warranty terms and conditions at www.ridefox.com Help Center/Powersports/Warranty or Contact a representative at:

1.800.FOX.SHOX (1.800.369.7469). A service RMA will be issued.

Ship shocks to one of the following service centers:

FOX Powersports Service
130 Hangar Way
Watsonville, CA 95076

FOX Midwest Service Center
13461 Dogwood Drive
Baxter, MN 56425