

4

3

2

1

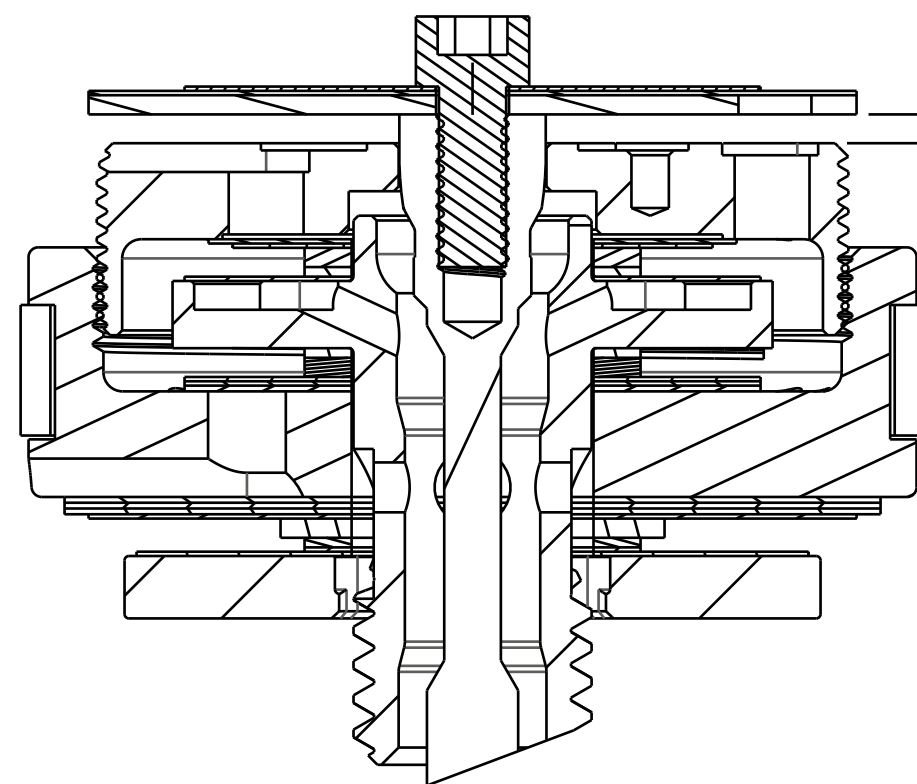

805-02-031-KIT
Piston Assembly: 2016 Float DPS, [Ø 0.940 Bore] w/ Glyde Ring

TORQUE:
60+/-5 IN-LB
CUSTOM SOCKET 398-00-637

210-10-120
Piston Bolt: Float DPS w/ Check 2mm Cross Holes [1/4-28 X 5/8 Hex]

222-01-316
Piston: Lockout, Float DPS V3 [.200 TLG, M20 X 0_.5] 416SS

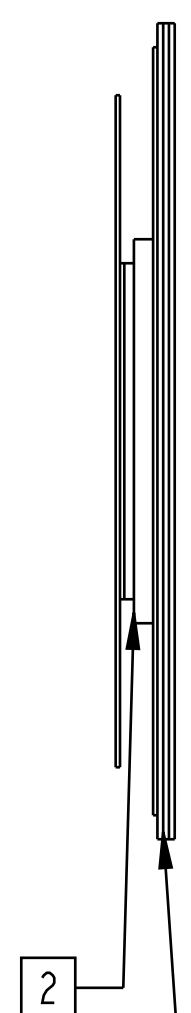
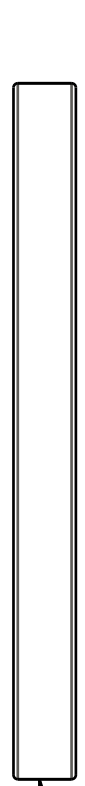

805-05-103-KIT
Valve Stack Assy: 2018 Float DPS, Digressive Compression Medium, DCM

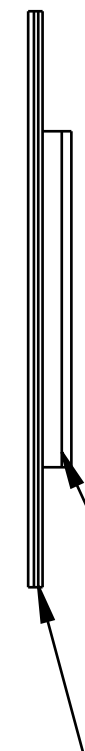
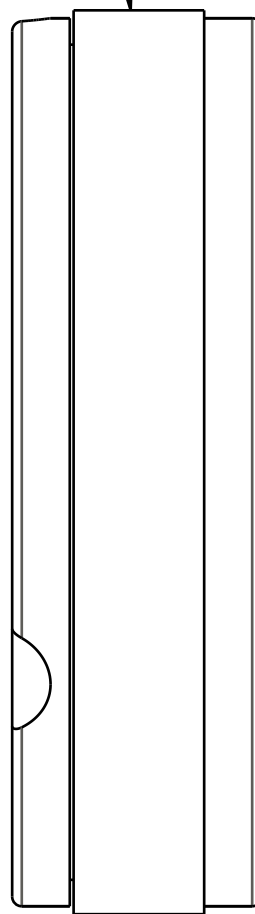

805-05-302-KIT
Valve Stack Assy: 2018 Float DPS, Digressive Rebound Firm, DRF

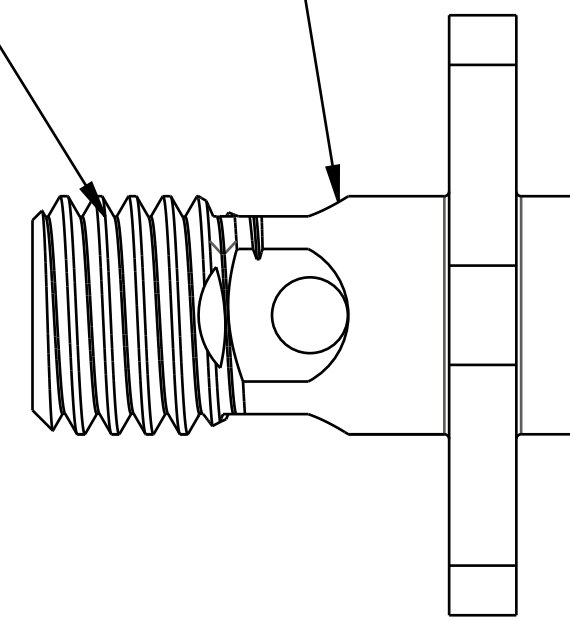

805-05-201-KIT
Valve Stack Assy: 2018 Float DPS, Lockout Firm, CMF

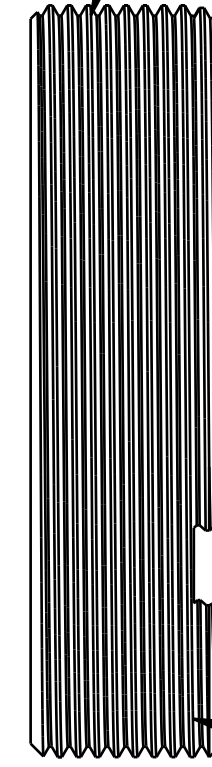

TORQUE:
22+/-2 IN-LB
CUSTOM SOCKET 398-00-638

210-10-098
FLOAT MY2013 Check Piston [.700 OD X .252 ID X .065 TH] Round CNC, SS

- NOTES: (UNLESS OTHERWISE SPECIFIED)
- SHOCK SHOULD HAVE 12-15 REBOUND CLICKS
 - SPACERS MAY BE ADDED OR REMOVED TO ADJUST NUMBER OF REBOUND CLICKS.
 - SPACERS MAY BE ADDED OR REMOVED TO ADJUST NUMBER OF REBOUND CLICKS.
 - SPACERS MAY BE ADDED OR REMOVED TO ADJUST LOCKOUT PLATE LIFT.
 - REFER TO INDIVIDUAL COMPRESSION, REBOUND, OR LOCKOUT VALVE STACK ASSEMBLY DRAWING FOR SPACER DETAILS AND TOTAL STACK HEIGHT MEASUREMENT.
 - USE .030-.047 LIFT SPEC FROM CLOSED TO OPEN FOR REMOTES WITH 210-30-090 OR 210-30-115 CAMS (TREK)

PROPRIETARY -
THIS DOCUMENT CONTAINS CONFIDENTIAL, PROPRIETARY INFORMATION
THAT IS FOX PROPERTY. DO NOT DISCLOSE TO OR DUPLICATE
FOR OTHERS EXCEPT AS AUTHORIZED BY FOX.

FOX Factory, Inc. Ph 831-768-1100
130 Hangar Way, Watsonville, CA 95076 USA Fax 831-768-9312

TITLE
**Valving Assy: 2018 Float DPS,
R/C, DCM, DRF, CMF [.940 Bore]**

SIZE DWG. NO.
C 807-06-220-KIT

PLOT SCALE 2.00:1 SHEET 1 OF 1

4

3

2

ProE ASSEM