

4

3

2

1

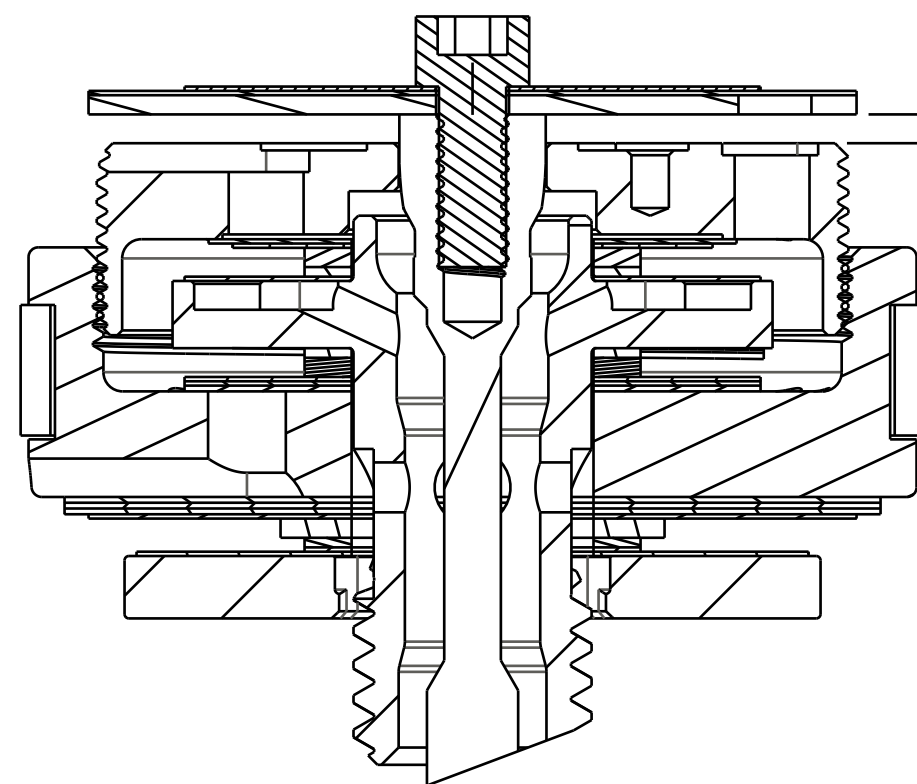

.030-.047
[0,77-1,19]
PLATE LIFT FROM CLOSED TO MIDDLE POSITION, ALL NON REMOTES + IRD [6]

.072-.090
[1,83-2,29]
PLATE LIFT FROM CLOSED TO OPEN POSITION, ALL CABLE REMOTES EXCEPT NOTE [6]

805-02-031-KIT
Piston Assembly: 2016 Float DPS, [Ø 0.940 Bore] w/ Glyde Ring

TORQUE:
60+/-5 IN-LB
CUSTOM SOCKET 398-00-637

210-10-120
Piston Bolt: Float DPS w/ Check 2mm Cross Holes [1/4-28 X 5/8 Hex]

222-01-297
Piston: Lockout, Float DPS V2 [.200 TLG, M20 X 0.5] 416SS

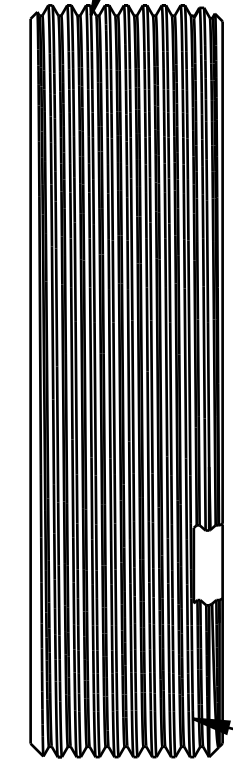
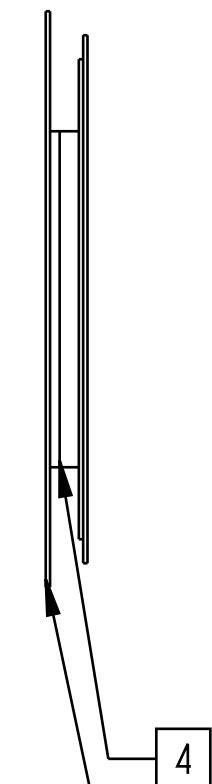
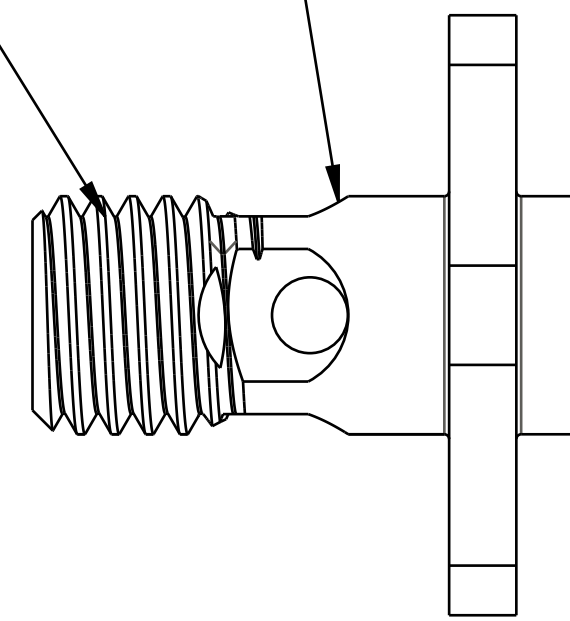
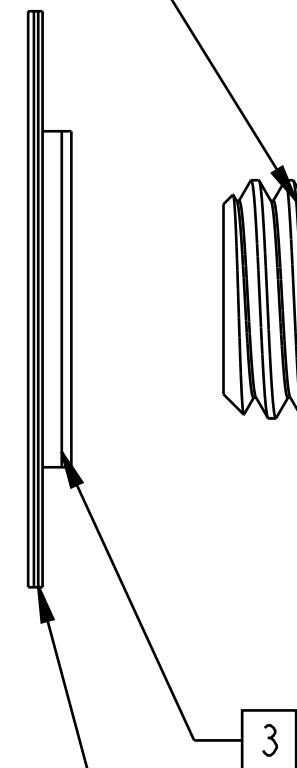
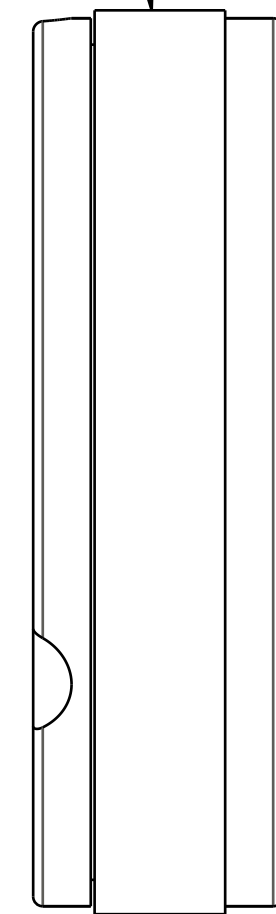
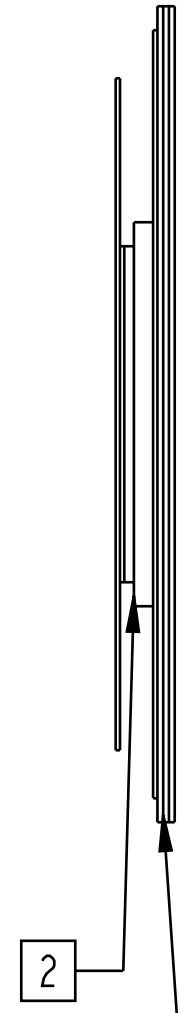
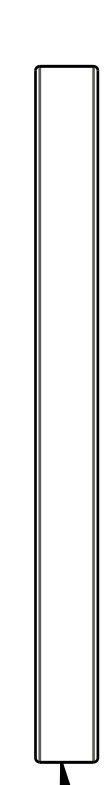

TORQUE:
22+/-2 IN-LB
CUSTOM SOCKET 398-00-638

210-10-098
FLOAT MY2013 Check Piston [.700 OD X .252 ID X .065 TH] Round CNC, SS

805-05-101-KIT
Valve Stack Assy: 2018 Float DPS, Digressive Compression Light, DCL

805-05-300-KIT
Valve Stack Assy: 2018 Float DPS, Digressive Rebound Light, DRL

805-05-200-KIT
Valve Stack Assy: 2018 Float DPS, Lockout Light, CML

- NOTES: (UNLESS OTHERWISE SPECIFIED)
1. SHOCK SHOULD HAVE 12-15 REBOUND CLICKS
 - [2] SPACERS MAY BE ADDED OR REMOVED TO ADJUST NUMBER OF REBOUND CLICKS.
 - [3] SPACERS MAY BE ADDED OR REMOVED TO ADJUST NUMBER OF REBOUND CLICKS.
 - [4] SPACERS MAY BE ADDED OR REMOVED TO ADJUST LOCKOUT PLATE LIFT.
 5. REFER TO INDIVIDUAL COMPRESSION, REBOUND, OR LOCKOUT VALVE STACK ASSEMBLY DRAWING FOR SPACER DETAILS AND TOTAL STACK HEIGHT MEASUREMENT.
 - [6] USE .030-.047 LIFT SPEC FROM CLOSED TO OPEN FOR REMOTES WITH 210-30-090 OR 210-30-115 CAMS (TREK)

PROPRIETARY -
THIS DOCUMENT CONTAINS CONFIDENTIAL, PROPRIETARY INFORMATION
THAT IS FOX PROPERTY. DO NOT DISCLOSE TO OR DUPLICATE
FOR OTHERS EXCEPT AS AUTHORIZED BY FOX.

FOX Factory, Inc. <small>130 Hangar Way, Watsonville, CA 95076 USA</small> <small>Ph 831-768-1100 Fax 831-768-9312</small>	
TITLE	Valving Assy: 2018 Float DPS, N/R, DCL, DRL, CML [.940 Bore]
SIZE	807-06-264-KIT
DWG. NO.	
PLOT SCALE	2.00:1
SHEET 1 OF 1	

4

3

2

1

ProE ASSEM