

4

3

2

1

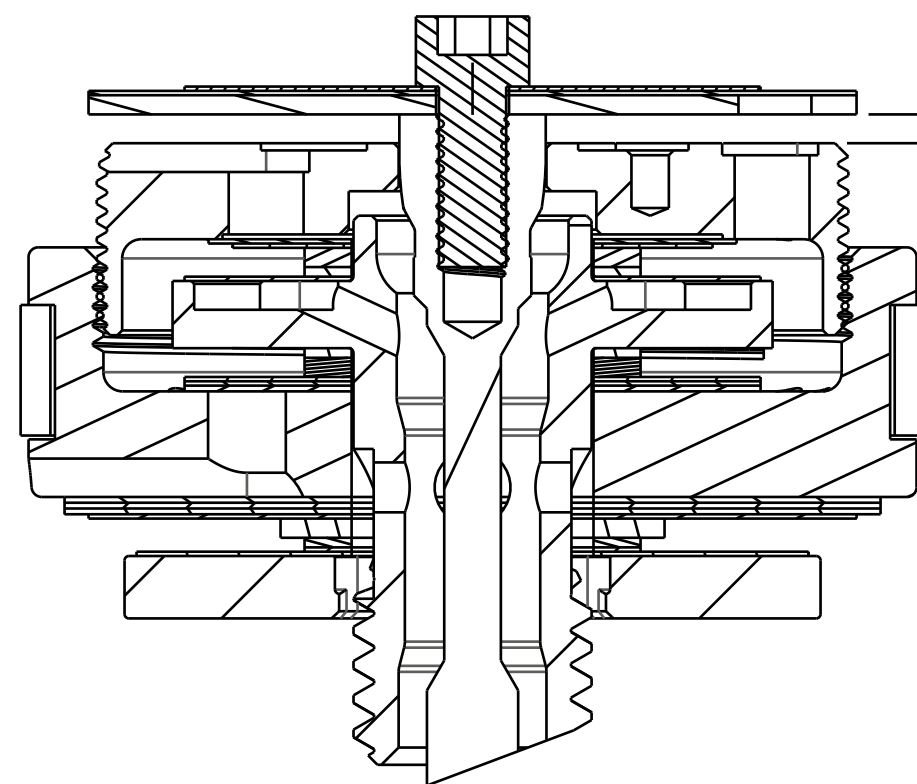

805-02-031-KIT  
Piston Assembly: 2016 Float DPS, [Ø 0.940 Bore] w/ Glyde Ring

TORQUE:  
60+/-5 IN-LB  
CUSTOM SOCKET 398-00-637

210-10-120  
Piston Bolt: Float DPS w/ Check 2mm Cross Holes [1/4-28 X 5/8 Hex]

222-01-297  
Piston: Lockout, Float DPS V2 [.200 TLG, M20 X 0.5] 416SS

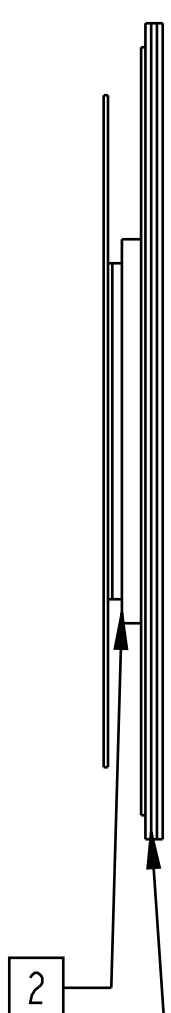
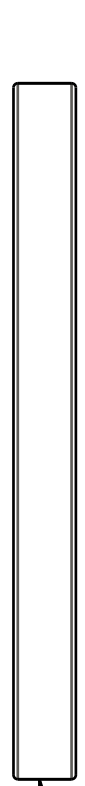

805-05-102-KIT  
Valve Stack Assy: 2018 Float DPS, Digressive Compression Light+, DCL+

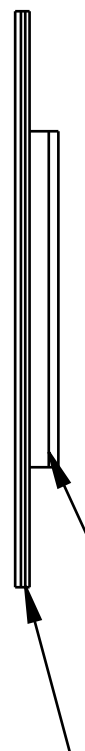
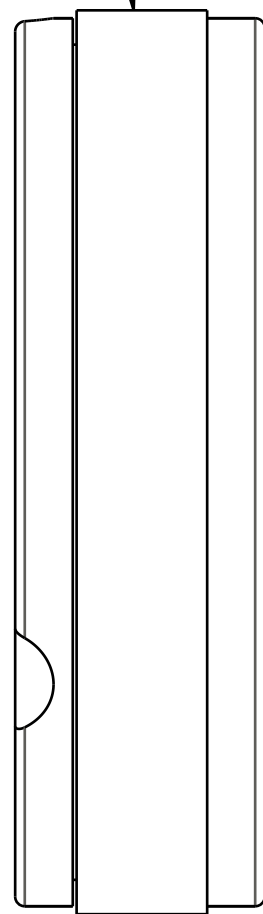

805-05-302-KIT  
Valve Stack Assy: 2018 Float DPS, Digressive Rebound Firm, DRF

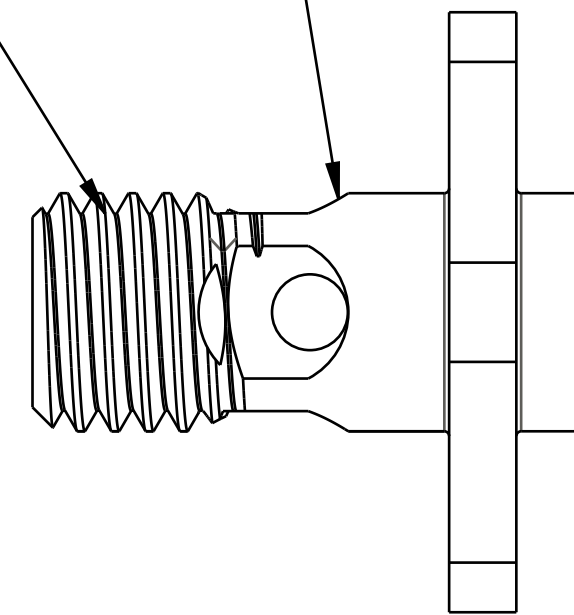

805-05-201-KIT  
Valve Stack Assy: 2018 Float DPS, Lockout Firm, CMF

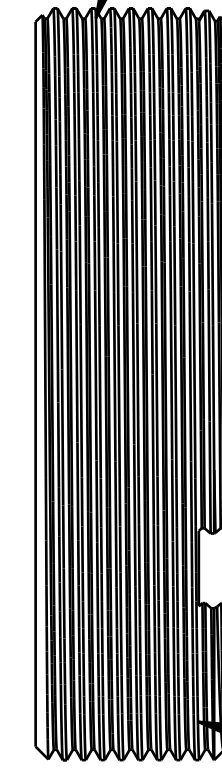

TORQUE:  
22+/-2 IN-LB  
CUSTOM SOCKET 398-00-638

210-10-098  
FLOAT MY2013 Check Piston [.700 OD X .252 ID X .065 TH] Round CNC, SS

NOTES: (UNLESS OTHERWISE SPECIFIED)

1. SHOCK SHOULD HAVE 12-15 REBOUND CLICKS
- [2] SPACERS MAY BE ADDED OR REMOVED TO ADJUST NUMBER OF REBOUND CLICKS.
- [3] SPACERS MAY BE ADDED OR REMOVED TO ADJUST NUMBER OF REBOUND CLICKS.
- [4] SPACERS MAY BE ADDED OR REMOVED TO ADJUST LOCKOUT PLATE LIFT.
5. REFER TO INDIVIDUAL COMPRESSION, REBOUND, OR LOCKOUT VALVE STACK ASSEMBLY DRAWING FOR SPACER DETAILS AND TOTAL STACK HEIGHT MEASUREMENT.
- [6] USE .030-.047 LIFT SPEC FROM CLOSED TO OPEN FOR REMOTES WITH 210-30-090 OR 210-30-115 CAMS (TREK)

PROPRIETARY -  
THIS DOCUMENT CONTAINS CONFIDENTIAL, PROPRIETARY INFORMATION  
THAT IS FOX PROPERTY. DO NOT DISCLOSE TO OR DUPLICATE  
FOR OTHERS EXCEPT AS AUTHORIZED BY FOX.

**FOX** FOX Factory, Inc. Ph 831-768-1100  
130 Hangar Way, Watsonville, CA 95076 USA Fax 831-768-9312

TITLE  
Valving Assy: 2018 Float DPS,  
N/R, DCL+, DRF, CMF [.940 Bore]

SIZE DWG. NO.  
C 807-06-284-KIT

PLOT SCALE 2.00:1 SHEET 1 OF 1

4

3

2