

4

3

2

1

D

D

C

C

B

B

A

A

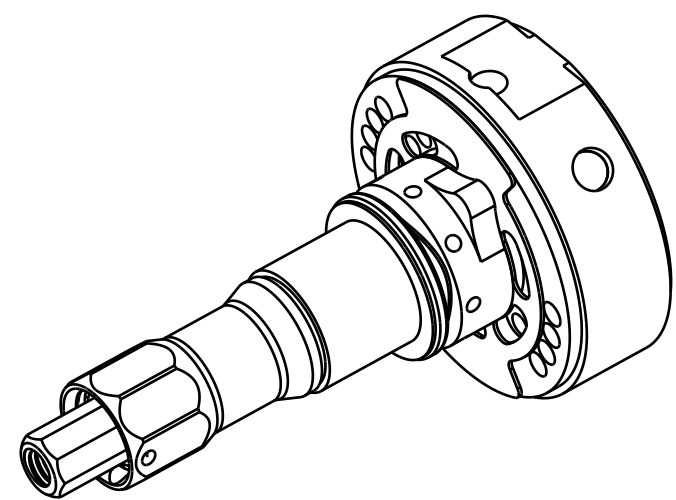

Retaining Ring: Wire [0.340 OD X 0.024" Wire] 17-7 SST

Butterfly Valve

Ball [Ø.1094]

Piston, Compression, FIT4, Dished, Aluminum

Compression Adjust Needle, F-S, FIT4

SHAFT, COMPRESSION SELECTOR, F-S, FIT4

GREASE:
THIN LAYER
OF SLICK HONEY

Compression Adjust Coupler, F-S, FIT4

Lockout Selector, F-S, FIT4

Spring: Wave [.322 ID x .420 OD, 3 Waves] SS

Bearing, Thrust, Teflon, FIT4, Selector Shaft, 2018

Seals: O-Ring [3.0MM ID x 1.5MM CS] Metric, N-70, Static

Ball [Ø.1094]

Retaining Ring: Wire [.280 OD X .024 CS] SS

Spring: Detent [.138 TLG, .087 OD, 48 lb/in]

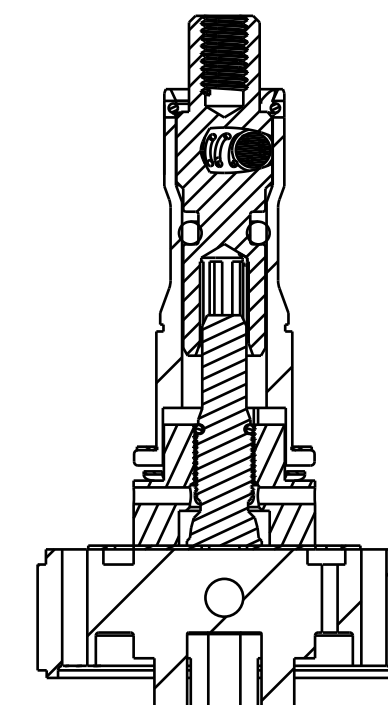

- PROPRIETARY -
THIS DOCUMENT CONTAINS CONFIDENTIAL, PROPRIETARY INFORMATION
THAT IS FOX PROPERTY. DO NOT DISCLOSE TO OR DUPLICATE
FOR OTHERS EXCEPT AS AUTHORIZED BY FOX.

FOX FOX Factory, Inc. Ph 831-768-1100
130 Hangar Way, Watsonville, CA 95076 USA Fax 831-768-9312

TITLE
2021 34 FIT4 REMOTE TOPCAP PARTS

SIZE DWG. NO.
C
PLOT SCALE 2.00:1 SHEET 1 OF 1

4

3

2

1

ProE ASSEM